Table of Contents

BUS SYSTEM TROUBLESHOOTING

Subject	Page
Introduction.	3
Definitions.	4
Controller Area Network (CAN bus).	5
Introduction.	5
CAN bus topology.	6
Troubleshooting the CAN bus.	7
Diagnosis Bus (D-bus).	13
Introduction.	13
D-bus topology.	13
Troubleshooting the D-bus.	14
Information and Body Bus.	16
Introduction.	16
I/K bus topology.	18
Troubleshooting the I/K-bus	19
Peripheral Bus (P-bus).	23
Introduction.	23
P-bus topology.	24
Troubleshooting the P-bus.	25
Motor Bus (M-bus).	26
Introduction.	26
M-bus topology.	28
Troubleshooting the M-bus.	28
Review Questions.	31

BUS SYSTEM TROUBLESHOOTING

Model: All Models Using Bus Systems

Production Date: From Model Year 1991

Objectives:

After completing this module you should be able to:

- Review the advantages of using bus systems in a vehicle.
- Review the various bus systems used in most BMW vehicles.
- Understand the operating principle of a serial bus.
- Review methods of troubleshooting bus lines using the diagnosis program.
- Recognize how to distinguish a correctly operating bus line on an oscilloscope.

Introduction

Up until the introduction of the E31, all information (e.g. RPM, temperature, vehicle speed, etc.) received and transmitted from a control unit were delivered by a dedicated wire. As the electronic systems used in the vehicle increased, so did the necessary wiring.

Wiring each device separately became a headache for production and finding space in the body to hold all of this wiring was becoming difficult, not to mention the effect on reliability and ever more complicated troubleshooting.

It soon became clear that a solution must be found, that solution was the bus system. The benefits of the bus system are:

- Greater reliability by reducing the number of wiring, connectors and components.
- Reduction in wire harness size by decreasing the number of interfaces between control units to one or two wires.
- Multiple utilization of sensors by transmitting information from one control unit to the next.
- Flexibility in system configuration and future applications.
- Reduction in costs for components, assembly and troubleshooting.

Today's vehicles have several bus systems that are divided according to groups of control units which share common functionality and information. Currently the bus systems in use are:

- CAN-bus
- D-bus
- I-bus
- K-bus
- P-bus
- M-bus

In the very near future the the complexity and number of control units in the vehicle will change, as will the structure and construction of the bus systems. However, the principle of operation will remain similar. Efficient troubleshooting of the new bus systems will rely on a thorough understanding and knowledge of the systems currently in use.

Definitions

Bus Line

A bus line is a group signal line that transmits serial data in both directions. It may consist of one wire or two. All control units are connected in parallel in current bus systems, this means that the information sent can be heard by all of the connected units.

Bus Subscriber

Any control module connected to a bus line. e.g. DME, IKE, GM, etc.

Gateway

A Gateway module provides a link between different bus lines to provide a means of sending information from a subscriber of one bus line to the subscriber of another. The Gateway module recognizes from the receiver address whether a message is to be routed through the gateway or not. e.g. IKE, KOMBI.

Master controller

A Master Controller of a bus system provides the operating voltage and wake up signals to the subscriber modules. This task may also be performed by several Standby Masters within a bus system. e.g. GM, LCM.

Serial Data

Serial means one event at a time. In data transmission, the technique of time division is used to separate bits of data sent. The messages sent over a bus are configured serially. Each message consists of:

1. Transmitter address
2. Length of data
3. Receiver address
4. Command or Information
5. Detailed description of message (data)
6. Summary of transmitted information (check sum)

All of the connected control units will receive the information but only the unit in the address will accept and react to the data.

Note: This message format is not used for the CAN Bus.

Topology

In the context of communication networks, Topology describes the configuration or arrangement of a network.

Controller Area Network (CAN Bus)

Introduction

The CAN bus is a serial communications bus in which all connected control units can send as well as receive information. Data over the CAN operates at a rate of up to 500 K/bps (kilobits per second).

The CAN protocol was originally developed by Intel™ and Bosch in 1988 for use in the automotive industry to provide a standardized, reliable and cost-effective communications bus for a cars electronics to combat the increasing size of wiring harnesses.

The CAN bus was originally introduced on BMW automobiles in the 1993 740i/iL as a data link between the DME and AGS control units.

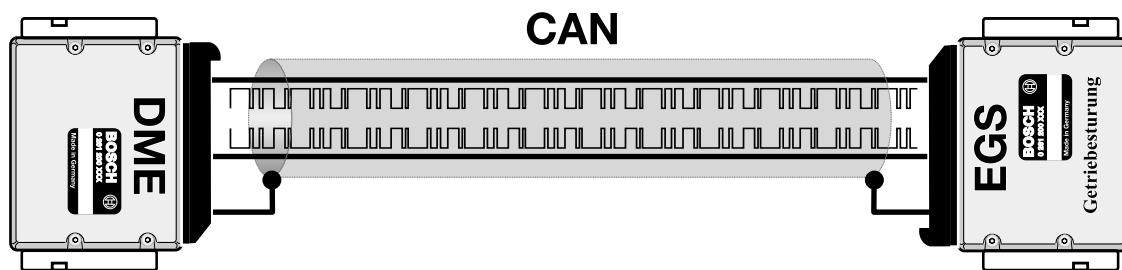

Data transmitted from any subscriber on a CAN bus does not contain addresses of the transmitting or receiving control unit. Instead, the content of the message (RPM, TD, Temp, etc) is labeled by an identifier code that is unique throughout the CAN. All of the subscribers receive the message and each one checks the message to see if it is relevant to that particular control unit.

If the message is relevant then it will be processed, if not, it will be ignored. The identifier code also determines the priority of the message. In a case where two control units attempt to send a message over a free bus line, the message with the higher priority will be transmitted first. The protocol of the CAN ensures that no message is lost, but stored by the sender and then re-transmitted later when it is possible.

CAN Bus Topology

The CAN bus consists of two twisted copper wires. Each wire contains an opposing signal with the exact same information (CAN-High, CAN-Low). The opposing signals transmitted through the twisted wire serve to suppress any electrical interference. Early CAN bus wiring included a grounded shield around the two wires, later vehicles discarded the shield in favor of the unshielded twisted pair wiring.

Due to the linear structure of the network, the CAN bus is available for other modules in the event of a disconnected or failed control unit. This is referred to as a “Tree” structure with each control unit occupying a branch.

Example of Tree structure 95-97 E38 750iL

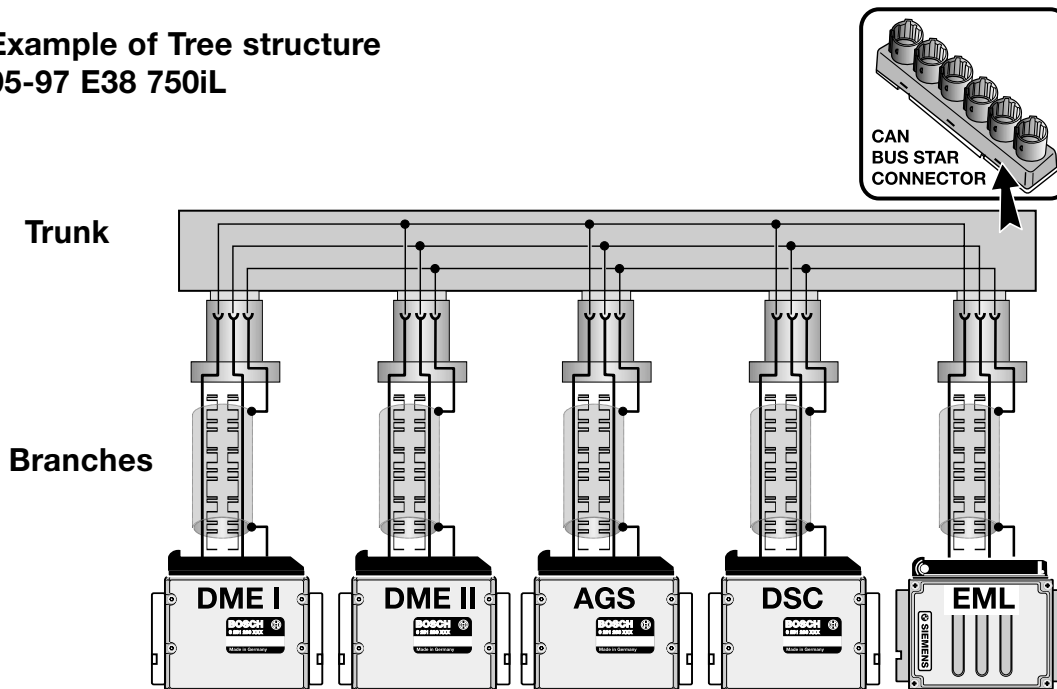

As previously mentioned, the CAN bus initially was used as a high speed communication link between the DME and AGS control units.

With the introduction of the E38 750iL (95 M.Y.), the CAN bus was expanded to include the EML and DSC control modules. The 750iL made exclusive use of the “star coupler” to link the individual CAN bus ends to a common connector.

The 1998 model year introduced new users of the CAN bus. The instrument cluster and the steering angle sensor were linked to expand the signal sharing capabilities of the vehicle.

The 1999 750iL was the last vehicle to use the shielded cable, after which the entire CAN bus went to twisted pair wiring.

Always refer to the ETM to determine the exact wiring configuration for a specific model.

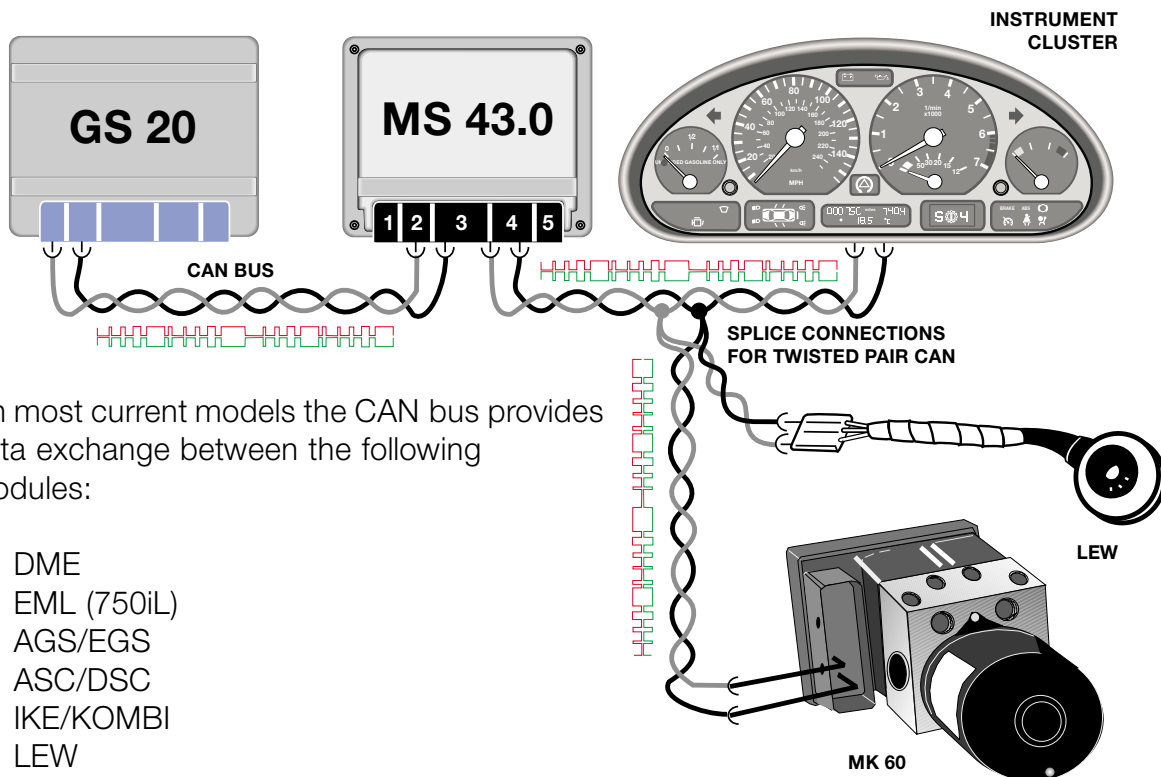

On most current models the CAN bus provides data exchange between the following modules:

- DME
- EML (750iL)
- AGS/EGS
- ASC/DSC
- IKE/KOMBI
- LEW

On models that use twisted pair, the wire color of the CAN bus is uniform throughout the vehicle with: CAN-Low GE/BR and CAN-High GE/SW or GE/RT. Shielded wiring is easily identified by the black sheath surrounding the CAN bus.

Troubleshooting the CAN Bus

The failure of communication on the CAN bus can be caused by several sources:

- Failure of the CAN bus cables.
- Failure of one of the control units attached to the CAN.
- Failure of the voltage supply or ground to individual modules.
- Interference in the CAN bus cables.
- Failure of a CAN bus resistor.

Failure of the CAN bus cables

The following faults can occur to the CAN bus wiring:

- CAN-H/L interrupted
- CAN-H/L shorted to battery voltage
- CAN-H/L shorted to ground
- CAN-H shorted to CAN-L
- Defective plug connections (damaged, corroded, or improperly crimped)

The voltage of the CAN bus is divided between the two data lines: CAN-High and CAN-Low for an average of 2.5V per line. The voltage measurement is taken from each data line to ground. CAN does not utilize a Master Controller, each module on the CAN provides operating voltage.

The fact that 2.5V are present does not mean that the CAN bus is fault free, it just means that the voltage level is available to support communication.

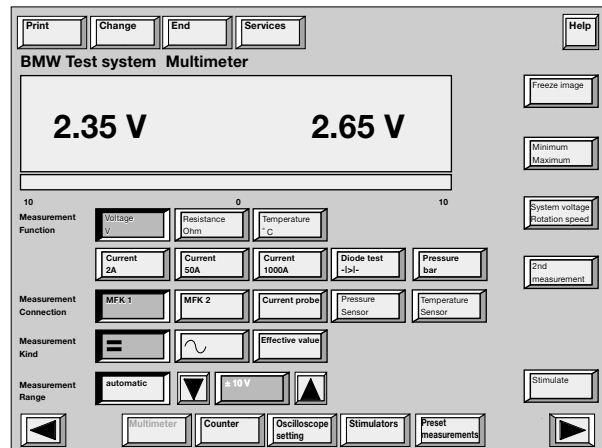

Terminal resistors: are used in the CAN bus circuit to establish the correct impedance to ensure fault free communication. A 120 Ohm resistor is installed in **two** control units of the CAN between CAN-H and CAN-L. Because the CAN is a parallel circuit, the **effective resistance** of the complete circuit is **60 Ohms**. On some vehicles there is a jumper wire that connects the two parallel branches together, others have an internal connection at the instrument cluster.

The resistance is measured by connecting the appropriate adapter to any of the modules on the CAN and measuring the resistance between CAN-L and CAN-H. The resistance should be **60 Ohms**. The CAN bus is very stable and can continue to communicate if the resistance on the CAN bus is not completely correct; however, sporadic communication faults will occur.

The terminal resistors are located in the ASC/DSC control unit and either the instrument cluster or in the DME.

Early 750iL vehicles that used the star connector have a separate external resistor which connect CAN-H and CAN-L together.

Modules which do not have the terminal resistor can be checked by disconnecting the module and checking the resistance directly between the pins for CAN-H and CAN-L. The value at these control units should be between 10kOhms and 50kOhms.

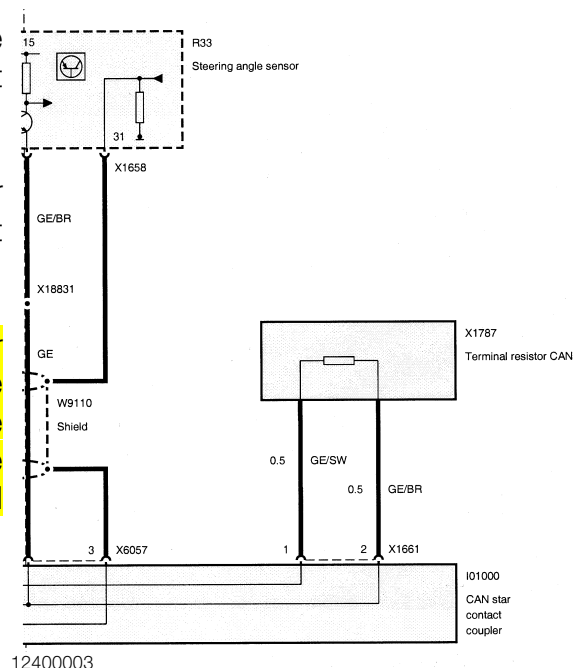

If there are CAN communication faults that use the term **“Timeout”** this refers to a module not being able to communicate with another on the bus. Each module on the CAN bus will attempt communication several times. If unsuccessful, the module will store a “Timeout” or “CAN bus” fault and determine that there is a problem with either the bus line or the module that it is trying to communicate with.

These types of faults may indicate a problem with the bus wiring, interference, missing data or failure of the communication module of an individual control unit.

Checking the CAN lines is carried out just like any other wiring. Perform continuity tests between the connections of different modules (all modules disconnected) without forgetting to make sure that the two CAN lines have not shorted to ground or to each other. **It is recommended to use the “Wire Test” in “Preset Measurements” which is more sensitive than just a resistance check.**

If Voltage level and the wire test are O.K, then looking at the communication signal may be useful.

The following are some examples of scope patterns that may be observed when checking the CAN bus.

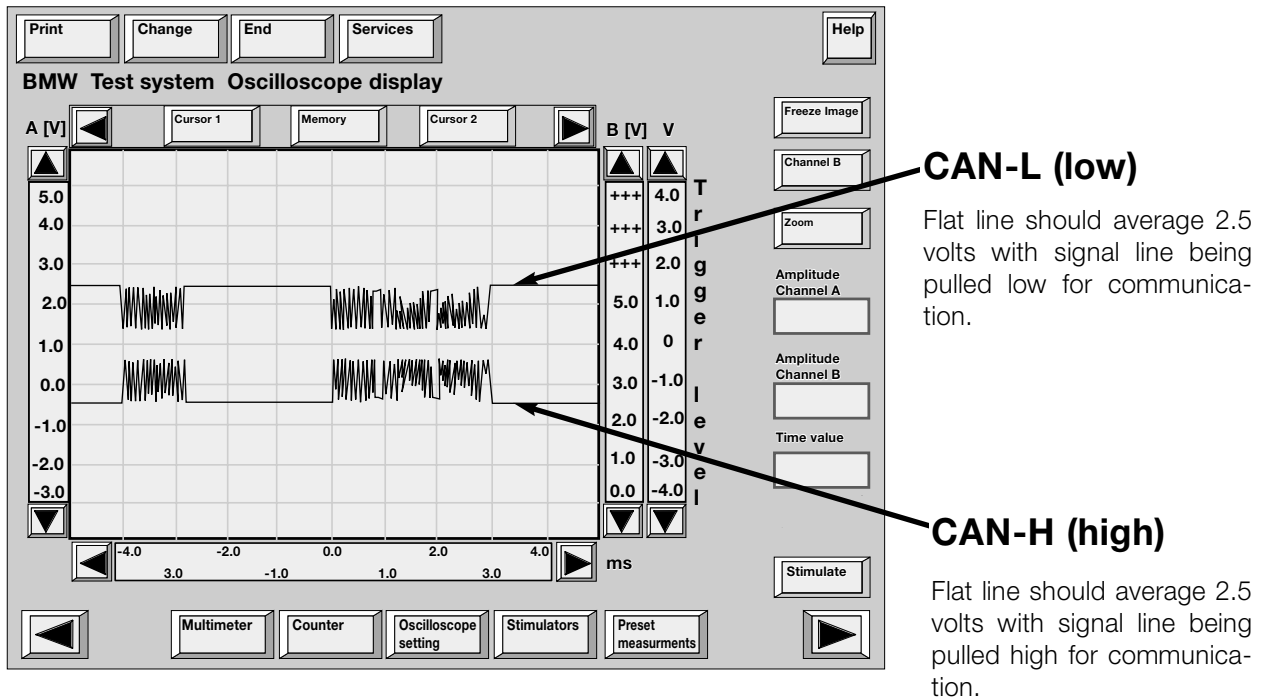

Example of correctly operating CAN bus

Correct communication on the CAN bus occurs in sporadic bursts with short periods of steady voltage.

Examples of Defective CAN bus signals

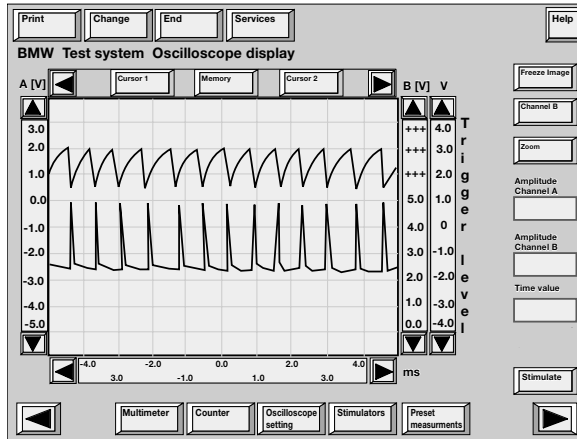

Rapid Constant fixed duty cycle for 10 seconds.

This example represents the output signal produced by an AGS module that is isolated from the bus. This pattern times out after 10 seconds and remains a flat line at 2.5 volts until the key is cycled and the event is repeated.

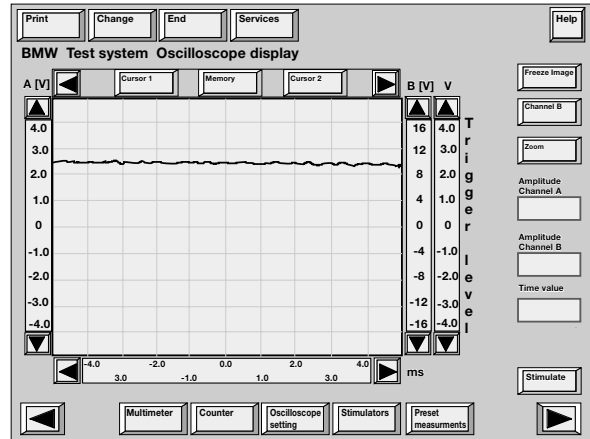

Flat line at 2.5 volts

If a continuous flat line is present at one or both CAN lines of a particular control unit, this may indicate that the CAN is open to that particular module. The module may have timed out and is waiting for a signal from another control unit. Check the CAN bus at other points to see if communication is occurring else where on the bus.

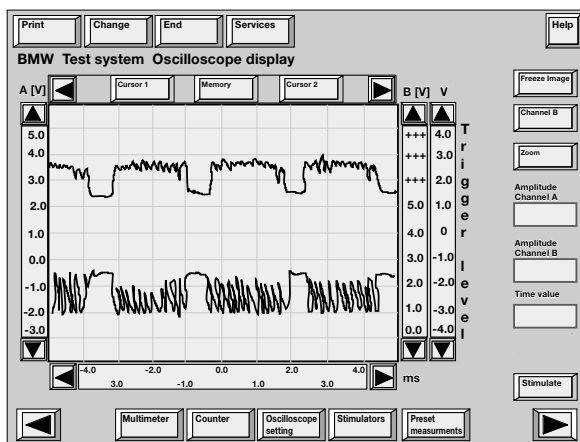

Constant fixed duty no time limit

All of the other control units with the exception of most current AGS modules will continue to try and send information even though the control unit has already stored a "Timeout" or CAN fault. This type of signal may only be seen if a section or all of the CAN bus is disconnected.

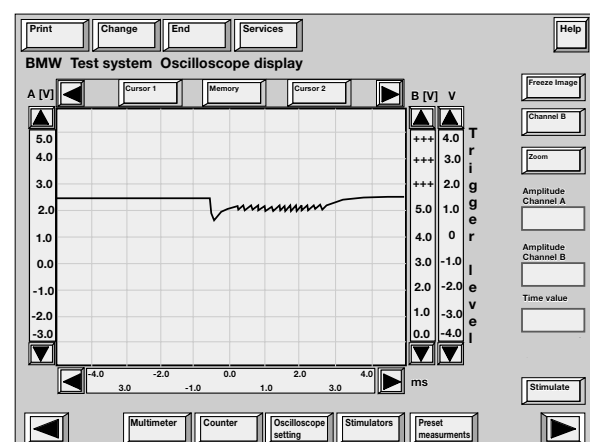

CAN High shorted to CAN Low

If the CAN bus lines were to become shorted to one another then the signals would cancel each other out and effectively be a flat line.

Failure of one of the control units attached to the CAN.

Each control unit connected to the CAN has an integrated communication module that makes it possible for that control unit to exchange information on the CAN. Failure of a control unit normally triggers a fault code in the other control units connected to the bus.

There are instances where failure of a module may paralyze or take down the entire CAN bus. This scenario would be evident by CAN faults stored in every control unit on the bus.

In order to isolate the defective control unit, the control units can be disconnected one at a time while monitoring the status of the CAN using a Voltmeter or oscilloscope. This can be further reinforced by clearing the faults of the remaining control units and then reading them again. **If the disconnected control module is the defective one, the faults will only point to communication with that interrupted module and no one else.**

As a quick check on vehicles produced after 9/97 (3/98 for the E39 528i) that have the CAN connection to the Instrument cluster, the indicators provide visual indication of whether communication is restored.

If for example the tachometer and temperature display are plausible then communication is occurring between the DME and IKE/KOMBI. Other indicators such as transmission range or the DSC light may give clues to the communication status with those control units.

Once the module has been replaced and coded or programmed, perform the CAN bus Test Module in each control unit to ensure that communication is OK.

E38/E39 Style diagnosis test module

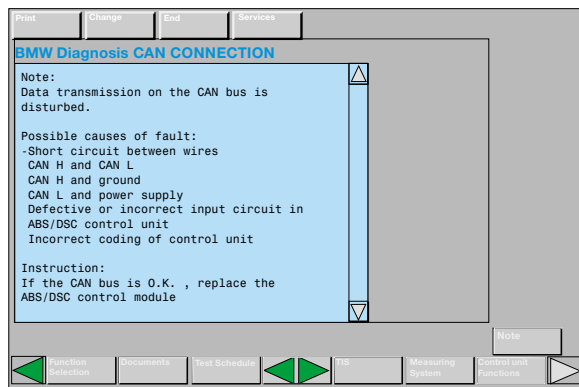

07400001

E46 Style diagnosis test module

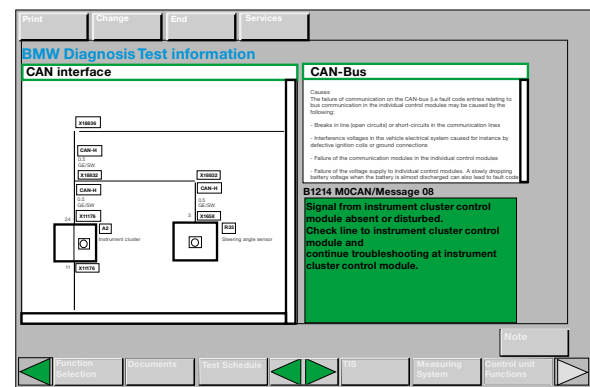

07400002

Failure of the voltage supply to individual modules.

A slowly dropping battery voltage or a vehicle with discharged battery can lead to sporadic communication faults in various control units on the bus. The reason is that not all control units will switch off communication at the same voltage level leaving some modules still trying to communicate. Always verify a properly charged battery and charging system before beginning troubleshooting on the CAN.

Interference in the CAN bus cables.

Interference will have a similar effect to shorting or disturbing the CAN bus wiring. Excessive interference created by a defective alternator or aftermarket devices such as cell phones or amplifiers may induce a voltage into the CAN bus line and disrupt communication. This type of interruption may be intermittent and faults may only be stored in some modules and not in others. These faults are often difficult to reproduce. Begin by eliminating any problems with the CAN bus wiring itself and verify that the generator is operating fault free. Isolate any aftermarket wiring in the vehicle and see if the fault returns.

Programming

During programming it should be noted that the module being programmed will not be communicating and therefore the other control units on the bus will store faults. These faults stored during programming should be deleted and then the fault memory should be read again to verify that they do not return. An incorrectly programmed module results in CAN faults that are not able to be cleared. **Remember to always verify the correct Programmed Part Number after programming.**

Diagnosis Bus (D-bus)

Introduction

The D-bus is a serial communications bus which can transmit data between the BMW DIS or MoDiC and the connected control units. The control unit to be subject to diagnosis is selected by sending a diagnosis telegram to the control unit address. By request from the tester, the control unit can transmit information and the contents of the fault memory or activate a control unit output. The D-bus is only active when the DIS or MoDiC is connected to the diagnostic socket and communicating.

The D-bus is actually the oldest bus system used in BMW vehicles, it was introduced in 1987 as TXD which provided communication between DME and the Sun 2013 Service Tester. The D-bus is still referred to as TXD in the ETM.

Data over the D-bus currently operates at a rate of up to 9.6 Kbps (bits per second).

D-Bus Topology

The D-bus (TXD) is connected to various control units that are diagnosed using DIS or MoDiC. Earlier vehicles also used a second diagnosis line called RXD to allow the test equipment to establish communication. RXD is not a bus line but a one way communication link used to wake up the diagnosis of the connected control unit.

On vehicles produced up to model year 2001 and use the 20 pin under-hood diagnostic connector, the locations of the two links are:

- RXD-Pin 15
- TXD-Pin 20

Later control modules (from 1997) no longer required the separate RXD to establish communication, (DS2 protocol) so Pin 15 was removed from the Diagnostic socket of most vehicles.

To satisfy the requirements of OBD II, in 1995 a standardized connector was installed inside of all vehicles. This connector has to provide access to all powertrain modules via an after-market scan tool. TXD II (pin 17) was introduced as a separate communication line exclusive to DME (ECM), AGS (TCM) and EML. TXD II is technically identical to the D bus (TXD).

On vehicles that use only the 16 pin OBD connector in the vehicle, TXD is installed in pin 8. TXD II remains in pin 7.

The term D bus was actually coined with the introduction of the E38 and the expanded use of bus systems in the vehicle. On vehicles from E38 on (except Z3), the D-bus is directly wired to:

- ASC/DSC
- EDC (if equipped)
- LEW
- IKE/KOMBI

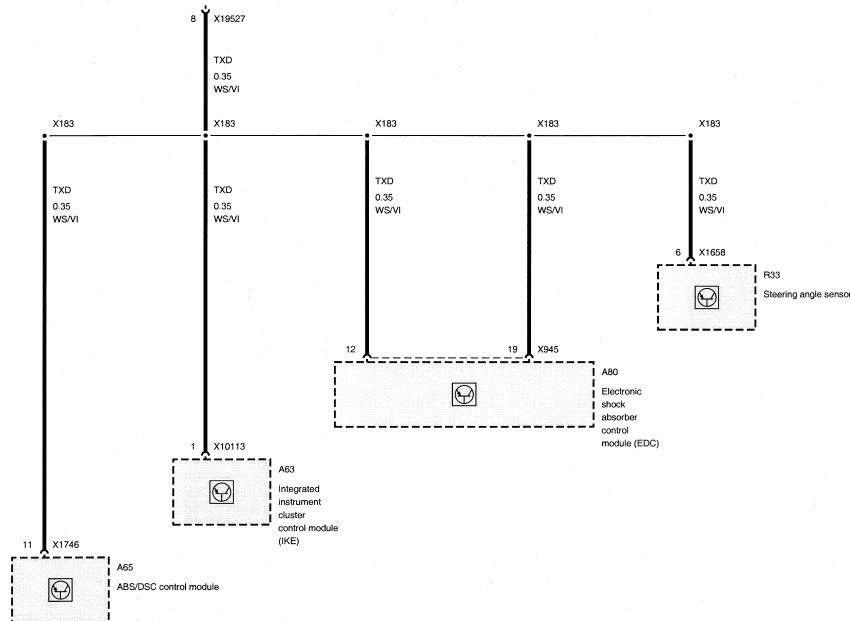

12400005

The IKE/KOMBI serves as the gateway for the D-bus that converts the telegram format of the I/K bus to the format of the D-bus.

The wire color of the D-bus is uniform throughout the vehicle, it is a single WS/VI wire.

Troubleshooting the D-Bus

The failure of communication with one or several control units via the D-bus can be caused by:

- Failure of the D-bus cable or its individual connections.
- Failure of the IKE/KOMBI control unit.
- Failure of the I/K or P-bus or its individual connections.
- Failure of the voltage supply or ground to individual modules.
- Interference in the D-bus cable.

Failure of the D-bus cable

The following faults can occur to the D-bus wiring:

- D-bus interrupted
- D-bus shorted to battery voltage
- D-bus shorted to ground
- Defective plug connections (damaged, corroded, or improperly crimped)

The operating voltage of the D-bus is 12 volts. The voltage measurement is taken from each data line connection to ground. Each module on the D-bus provides its own voltage.

The fact that 12V are present does not mean that the D-bus is fault free, it just means that the voltage level is sufficient to support communication.

Minimum voltages that are needed for fault free communication are:

- D-bus (TXD)/TXD II > 2.0V
- RXD (if equipped) > 10.5V

If problems are encountered trying to establish communication consider first:

- Battery charge level of the vehicle. Maintain a battery charger on the vehicle at all times during diagnosis.
- Always check that the diagnosis head and connection are OK before working through a test module for lack of communication.

On vehicles that use the IKE/KOMBI as a gateway:

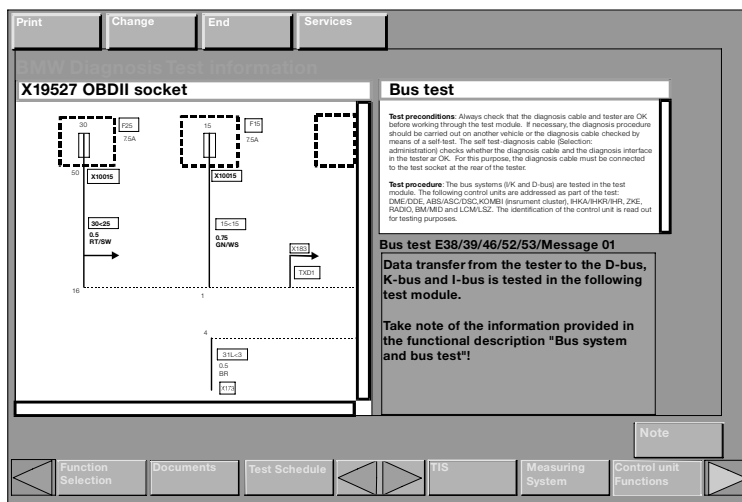

07400100

D-bus test module

If identification of the vehicle is carried out by the diagnostics without any problems then the D-bus is OK.

If several control units are not recognized this indicates that a bus link is defective. Continue troubleshooting using the test modules for those particular bus systems.

Information and Body Bus (I and K bus)

Introduction

The I and K buses are a serial communications bus in which all connected control units can send as well as receive information over one wire. The I and K bus are technically identical, the only difference is their use by model. From this point forward they will be referred to as the I/K bus and differences will be pointed out separately.

The I bus was originally introduced in the E31 to provide a standardized, reliable and cost-effective communications bus for a cars electronics to combat the increasing size of wiring harnesses.

The E38 expanded the use of bussing in BMW vehicles by adding three more busses (K, P and M) and adding more control units to the network.

The data transfer rate is approximately 9.6Kbps (bits per second).

The I/K-bus is always active when terminal R is switched on. If the bus line is quiet more than 60 seconds, all of the control modules will go into Sleep Mode.

When receiving messages over the bus line, the control unit first determines if the message is error free before accepting it.

The information sent over the bus is configured serially. Each message consists of:

1. Transmitter address (8 bit address)

- The senders name.

2. Length of data (number of following message bytes)

- How long the sender will speak.

3. Receiver address (8 bit address)

- Whom the sender wishes to speak to.

4. Command or Information

- What the sender wants done.

5. Detailed description of message (maximum 32 bytes of data)

- How the sender wants it done.

6. Summary of transmitted information (check sum)

- The sender summarizes everything said.

The sender of the message then waits (100ms) for an acknowledgement that the message was received.

All of the connected control units will receive the information, but only the module addressed will accept and react to the data.

The rules for communication on the bus line are:

- Only one module speaks at a time.
- Everybody speaks at the same speed.
- Messages are acknowledged by the recipient.
- The message is repeated if the addressed module fails to respond.
- The Master Controller has priority.
- Quit sending message after 5 failed attempts.

Communication between busses: On vehicles equipped with an I-bus (E38, E39, E53 High) messages to be sent back and forth between the K-bus and I-bus have to be transferred via a Gateway. This Gateway is the IKE. The IKE determines by the address of the message recipient whether the message needs to be passed along to the other bus. The D-Bus and CAN-Bus also utilize the IKE or KOMBI as a gateway.

Polling: Each module on the I/K bus is informed by a message from the Master Controller as to the ready status of all of the other connected modules. The modules polled are according to the coding of the Master Controller. Every 30 seconds after KL R is switched on, each module on the bus line is polled.

A message concerning bus subscriber status is updated continuously based on the results of these polls. If a subscriber fails to respond with “device status ready” the Master will try again after 1 second.

If the module fails to reply again, the Master will assume that the subscriber is defective and send the message “subscriber inactive” to all connected modules. The inactive module will continue to be polled until the key is switched off in case the module resets itself.

I/K Bus Topology

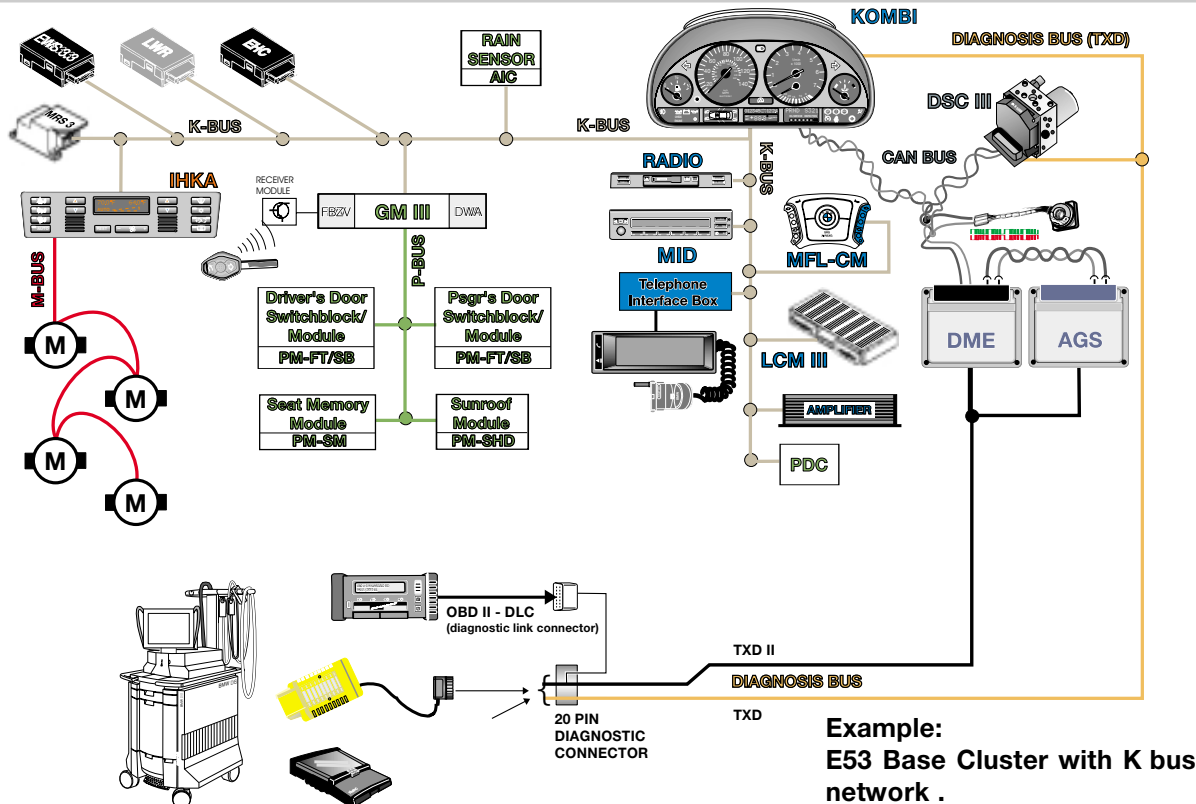
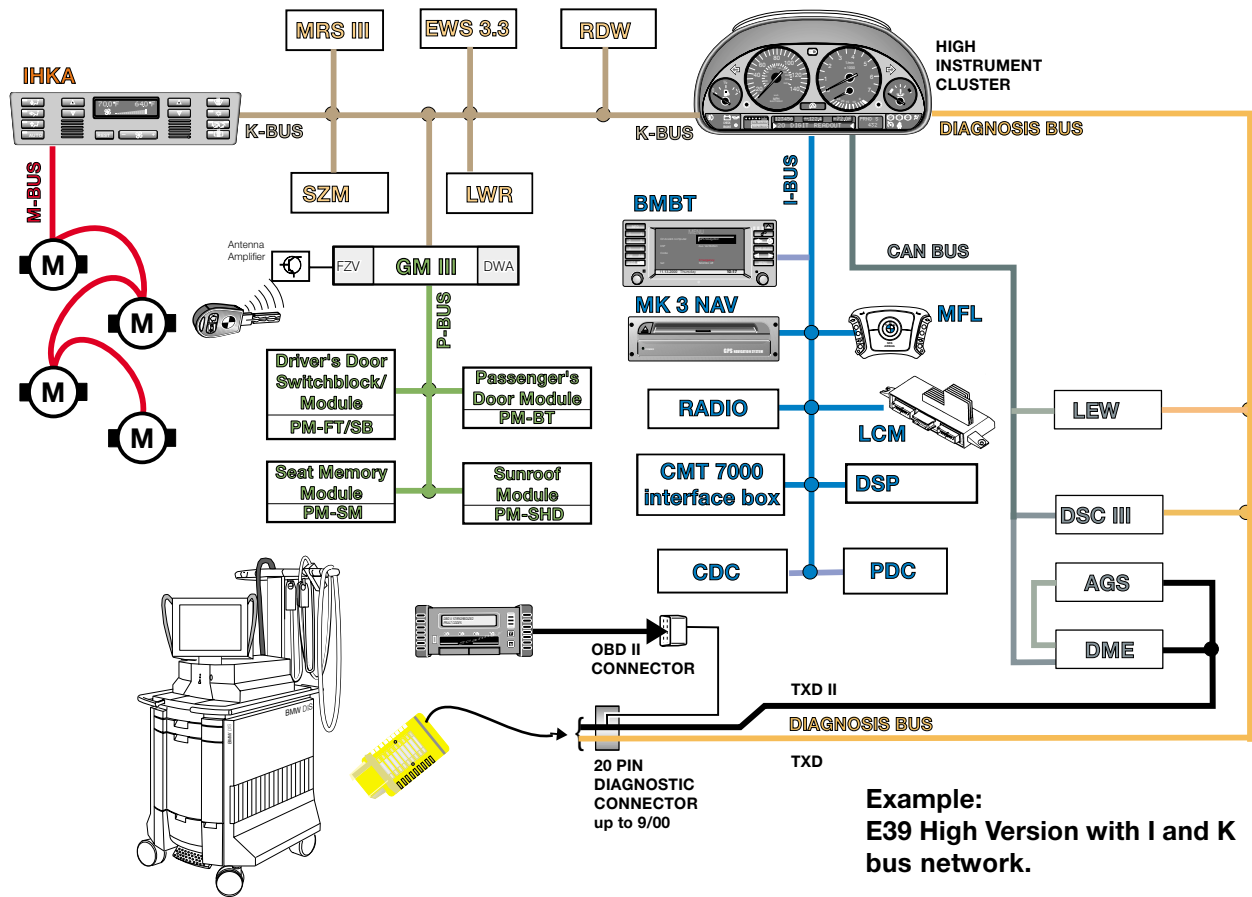

The I/K bus consists of a single copper wire. The wire color of the I and K bus is uniform throughout the vehicle with: I-bus WS/GR/GE and the K-bus WS/RT/GE (**Note: 2001 E39s with base Kombi have changed K-bus wire color to the same as the I-bus, WS/GR/GE.**)

Due to the linear structure of the network, the I/K bus is available for other modules in the event of a disconnected or failed control unit. Just as the CAN bus, this is referred to as a “Tree” structure with each control unit occupying a branch. The I/K-bus provides the diagnostic connection to the control units located on those busses (except IKE/KOMBI).

Always refer to the ETM to determine the exact wiring configuration and color for a specific model.

Troubleshooting the I/K bus

The failure of communication on the I/K bus can be caused by several sources:

- Failure of the bus cable.
- Failure of one of the control units attached to the bus.
- Failure of the voltage supply to individual modules.
- Interference in the bus cables.

The I/K bus is active when KL R is switched on, it remains active until 60 seconds after the last message. If the key is switched off (KL30) the bus may be activated for a time by individual users via a “wake-up” message.

Unlike the CAN bus where each control unit (subscriber) provides voltage for communication, the I/K-busses use only determined **Master** or **Stand-by Controllers** to supply B⁺ for communication. The voltage level on the I/K bus must be above 7V. The nominal value should be close to the system voltage of the vehicle.

Just like the CAN bus, the fact that voltage is present does not mean that the bus is fault free, it just means that the voltage level is sufficient to support communication.

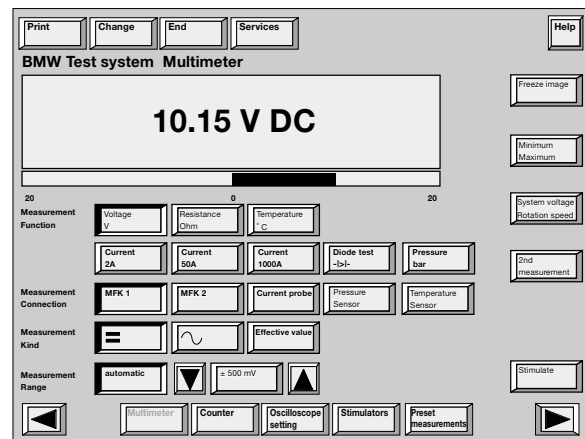

Control units that provide operating voltage to the I/K bus are:

On E38 and E39/E53 High version vehicles:

- The LCM is the Master Controller of the I-bus. The IKE and MID/BMBT are Stand-by Controllers.
- The GM is the Master Controller of the K-bus.

On E46, E52 and E39/E53 Base version vehicles:

- The GM is the Master Controller for vehicles equipped with only the K-bus.
- The LCM/LSZ is the Stand-by Controller.

Failure of the Bus cable

The following faults can occur to the I/K bus wiring:

- Short Circuit to B⁺
- Short Circuit to B⁻
- Bus line down (open)
- Defective plug connections (damaged, corroded, or improperly crimped)

Short Circuit to B⁺: Modules that send a message see that the message was not received and that the bus remains high. However, subscribers are unable to decide whether the fault is due to a shorted line or a defect in the communication interface. The module will repeat its message 5 times before discontinuing and faulting. The module will continue to operate as normal minus any commands that could not be delivered by the bus.

Short Circuit to B⁻: The subscribers do not interpret a low bus line as a fault but just as a bus line deactivation. The Master and Standby controllers do detect the short and enter it as a bus fault. (No communication).

Bus Line Down: The bus line may be open at any of several locations. As long as the Master or Stand-by is still connected, communication can occur with any modules still remaining. The fault situation will be the same as if the disconnected modules were defective themselves.

Checking the bus line is carried out just like any other wiring. Perform continuity tests between the connections of different modules (all modules disconnected) without forgetting to make sure that the bus has not shorted to ground or another wire. **It is recommended to use the “Wire Test” in “Preset Measurements” which is more sensitive than just a resistance check.**

If Voltage level and the wire test are O.K then looking at the communication signal may be useful. In order to get a signal, operate different devices on the I/K bus (e.g. MID/MFL) to stimulate conversations.

The following are some examples of scope patterns that may be observed when checking the I/K bus.

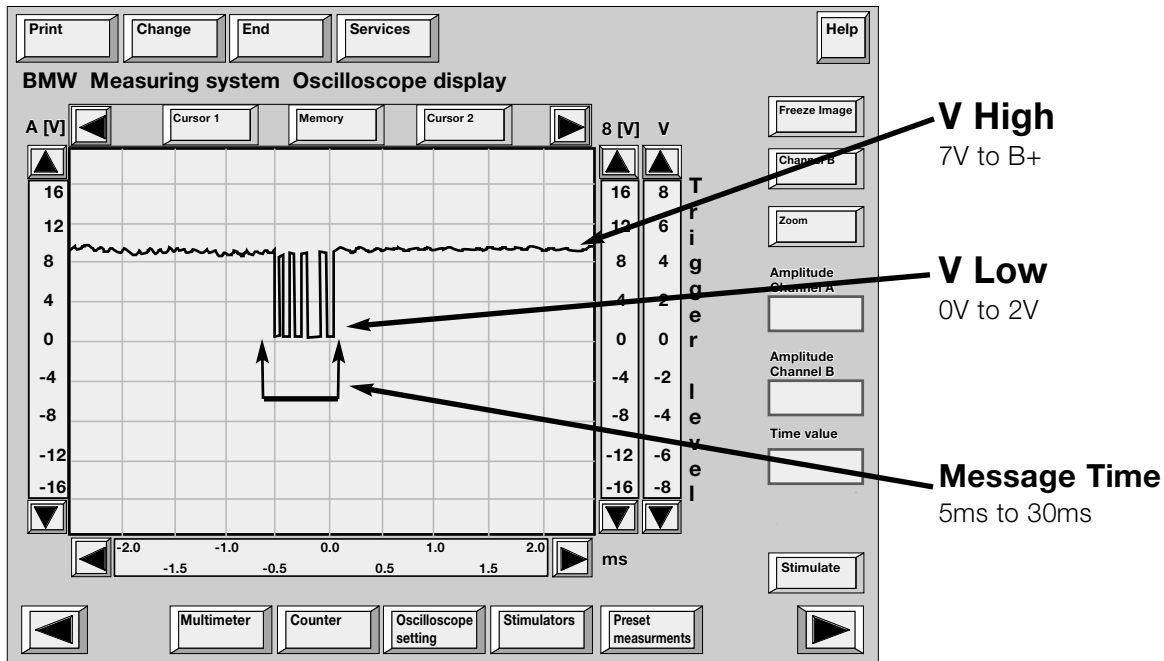

61400100

Example of correctly operating I/K bus *during* communication

Correct communication on the I/K bus occurs in sporadic bursts with periods of steady voltage around 12V.

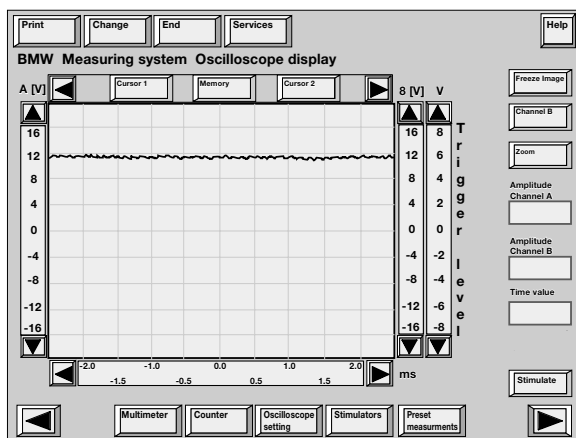

61400100

Flat line at 12 volts

No communication is currently taking place. The bus may be temporarily offline or shorted to B+.

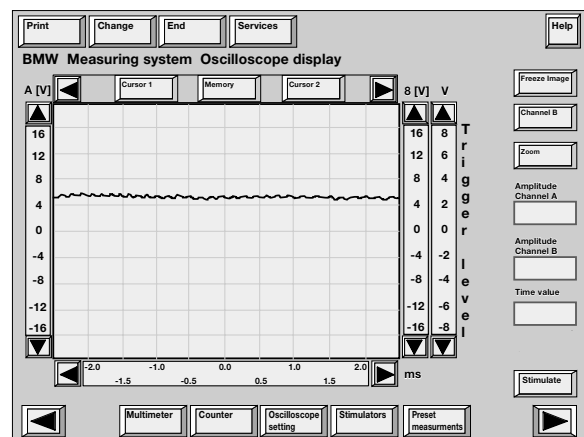

61400100

Flat line at 5 volts

No output voltage from the Master or Standby controllers. Bus line may be open or control unit may be defective.

Failure of one of the control units attached to the I/K bus.

Each control unit connected to the bus has an integrated communication module that makes it possible for that control unit to exchange information. Failure of a control unit normally triggers a fault code in the other control units connected to the bus.

As a quick check for the I/K-bus, activate the four way flashers. The flash indicators must light up in the instrument cluster. Switch on the Radio, and adjust volume using the MFL or MID/BMBT, the volume must change accordingly.

On High version vehicles press the recirculation button on the MFL, The IHKA should respond to the request. This test checks the gateway link as well as the the I and K bus communication.

If the tests prove O.K, this means that communication on the bus is O.K. Any faults still existing can only be related to faults specific to a control unit or a local I/K-bus wiring defect to a module.

There are instances where failures may be software related. A faulted module may paralyze or take down the entire bus. This scenario would be evident by functions not being carried out and and possible faults stored.

In order to isolate the defective control unit, the control units can be disconnected one at a time. Repeat the bus test after each disconnected control unit. If the disconnected control module is the defective one the faults will only point to communication with that interrupted module and no one else.

Once the module has been replaced (observing current S.I.Bs) and coded, perform the I or K bus Test Module in the Diagnosis Program to ensure that communication is O.K.

Failure of the voltage supply to individual modules.

A slowly dropping battery voltage on a vehicle with discharged battery can lead to sporadic communication faults in various control units on the bus. The reason is that not all control units will switch off communication at the same voltage level leaving some modules still trying to communicate. Always verify a properly charged battery and charging system and fuses before beginning troubleshooting on the bus. Also, do not forget to check for a proper ground to a control unit, this may not allow the bus to see a signal low (0-2V)

Interference in the bus cables.

Interference will have a similar effect to shorting or disturbing the bus wiring. Excessive interference created by a defective alternator or aftermarket devices such as cell phones or amplifiers may induce a voltage into the bus line and disrupt communication. This type of interruption may be intermittent and faults may only be stored in some modules and not in others. These faults are often difficult to reproduce. Isolate any aftermarket wiring in the vehicle and see if the fault returns.

Peripheral Bus (P-Bus)

Introduction

The P-bus is single wire serial communications bus that is used exclusively on vehicles that are equipped with ZKE III. When the E38 was introduced the objective was to reduce the complexity of the wiring harness. Peripheral modules are located in areas of the vehicle close to sensors or actuators where wiring the components separately would create an excessively large harness (e.g. door). In some cases (e.g. Sunroof module) these peripheral modules are integrated with an actuator or switch to create one unit. The peripheral modules are connected to the GM III by the P-bus.

The P-bus is only used in the body electronics area and is very similar in communication protocol and speed to the I/K-bus. The P-bus is not designed for rapid exchange of continuous information, rather, the messages on the P-bus are short control commands. This limited message flow allows for fast reaction time by the Peripheral module (e.g. a door lock or window request).

Go to sleep mode: The ZKE III goes to sleep after the key is switched off ,no messages are being sent and after 16 minutes. The GM is responsible for sending the “GO TO SLEEP” command to all of the P-bus subscribers.

Wake up: Controllers that have the capability of sending the wake-up call are the GM and the driver and passenger door modules. The wake up call is simply a P-bus low.

P-bus polling: When KL R is switched on the GM sends out a P-bus poll every 5 seconds to the modules that are coded as being installed. The P-module must respond in 5 seconds. If it does not respond the GM tries two more times. If the poll is still unanswered the GM enters it into fault memory.

Coding: The GM informs the P-modules of relevant coding data.

P-bus Topology

The extent of the P-bus depends on the special equipment of the vehicle.

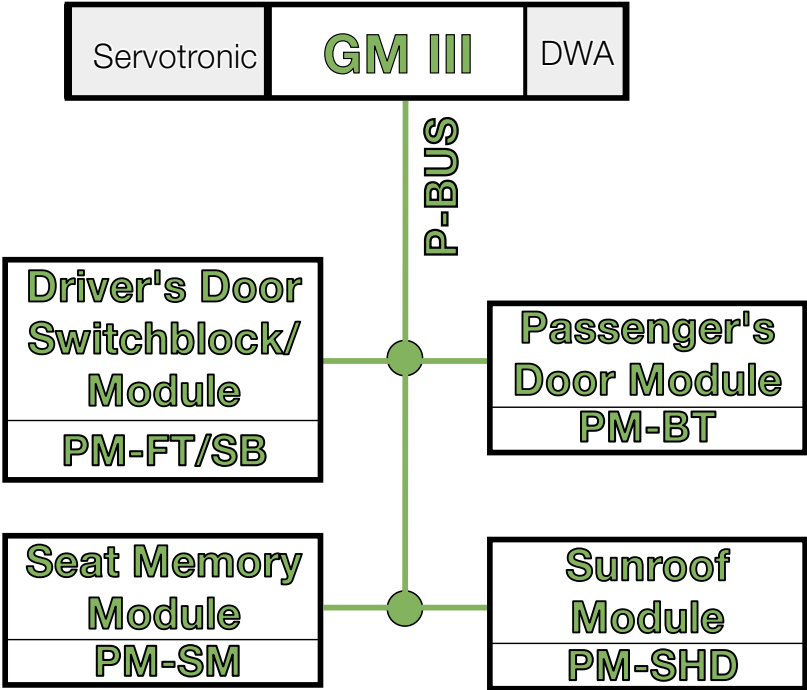

The P-bus consists of a single copper wire. The wire color of the bus is uniform throughout the vehicle: BL/RT.

Due to the linear structure of the network, the P-bus is available for other modules in the event of a disconnected or failed control unit. The P-bus provides the diagnostic connection to the P-modules.

Always refer to the ETM to determine the exact wiring configuration for a specific model.

Motor Bus (M-Bus)

Introduction

The M-bus is used exclusively between a climate control module, e.g. IHKA/IHKR and a set of stepper motors used to move various air distribution doors.

These “smart” stepper motors have an integrated communication I.C. that allows them to listen as well as transmit information over a single bi-directional data link.

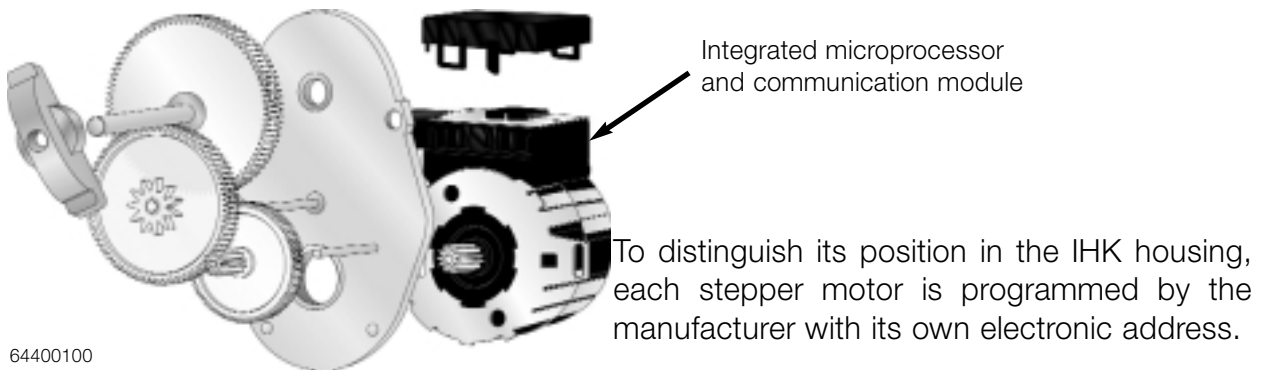

Each stepper motor on the M-bus also has a unique part number that is printed on the body of the motor. It is vital that each stepper motor be installed in its correct location for proper operation due to the addressing.

A three wire ribbon connector is used to connect the stepper motor to the IHK control unit. All of the stepper motors are connected in parallel to each other via the M-bus ribbon cable.

The ribbon contains:

- Power
- Ground
- Bi-directional signal wire

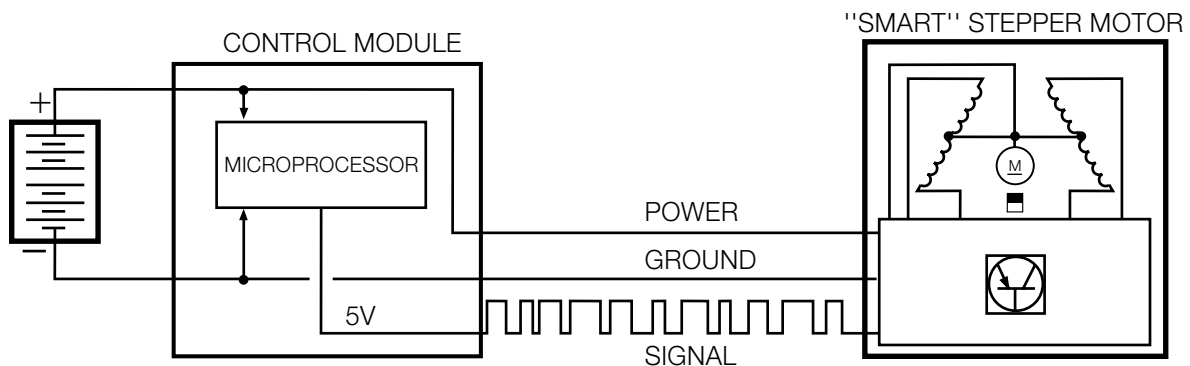

64400101

Each stepper motor acts as a “slave” , it listens to all data on the bus, but only accepts or responds as long as the message is transmitted without errors and it recognizes it’s own address.

M-bus protocol: The M-bus protocol differs from the CAN and the I/K/P busses in that communication takes place on a constant basis within a framework time of 650µs.

When the IHK module is commanding a change in position of one or more stepper motors the sequence of data is:

1. Start bit

- Informs the stepper motors that a command is coming.

2. Synchro bit

- Establishes the message as originating from the IHK control unit.

3. Data field

- The command to move a stepper motor to a particular position.

4. Address field

- The IHK control unit names the stepper motor the command is intended for.

If the message was received by the stepper motor without error (oversampling) the stepper will carry out the command and transmit its acknowledgement:

1. Synchro bit

- Establishes the message as originating from the stepper motor.

2. Data field

- Status information from the actuator (feedback).

3. End of frame

- Closes the communication session.

Communication continues on the M-bus until the GM sends the “go to sleep” command over the K-bus.

M-bus Topology

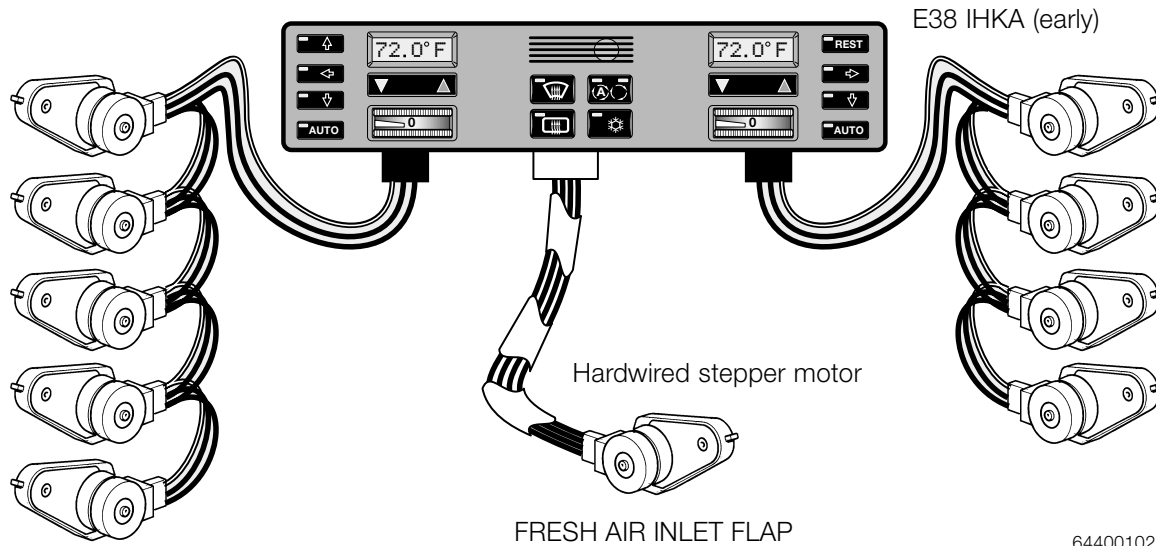

The M-bus consists of a three wire ribbon. On E38 vehicles because of the large number of stepper motors used, the M-bus is divided into two separate circuits. All other vehicles use a single M-bus cable. The M-bus wire ribbon is not routed with the rest of the vehicle harness but is a separate harness attached to the IHK housing.

Always refer to the ETM to determine the exact wiring configuration for a specific model.

M-bus Troubleshooting

The failure of communication on the M-bus can be caused by several sources:

- Failure of the bus ribbon, e.g. open or shorted.
- Failure of one of the stepper motors attached to the bus, e.g. shorted to B⁺ or B⁻.
- Failure of the voltage or ground supply to the IHK control unit.

The M-bus is active at any time following KLR on. The IHK module provides the voltage necessary to support communication. The voltage level of the M-bus is 5V, but because status communication occurs at an average 50% duty cycle the observed voltage is approximately 2.5V. The presence of 2.5V means that communication is occurring.

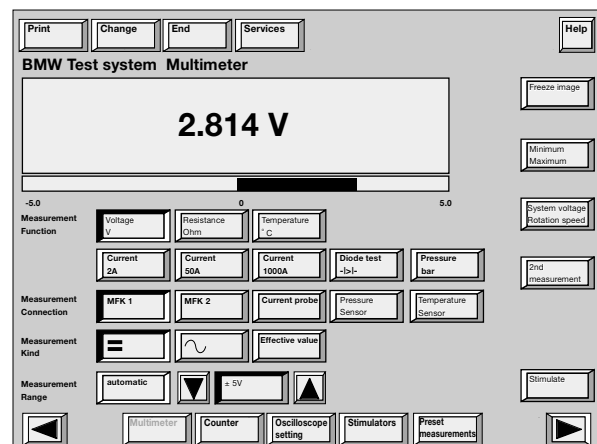

Checking the M-bus ribbon is carried out just like any other wiring. Perform continuity tests between the connections of the stepper motors (all motors disconnected) and the control unit without forgetting to make sure that the data line has not shorted to ground or power.

It is recommended to use the “Wire Test” in “Preset Measurements” which is more sensitive than just a resistance check.

If Voltage level and the wire test are O.K, then looking at the communication signal may be useful.

The following is an example of a scope pattern that may be observed when checking the M-bus. Notice the very high frequency of the signal at approximately 20 kHz.

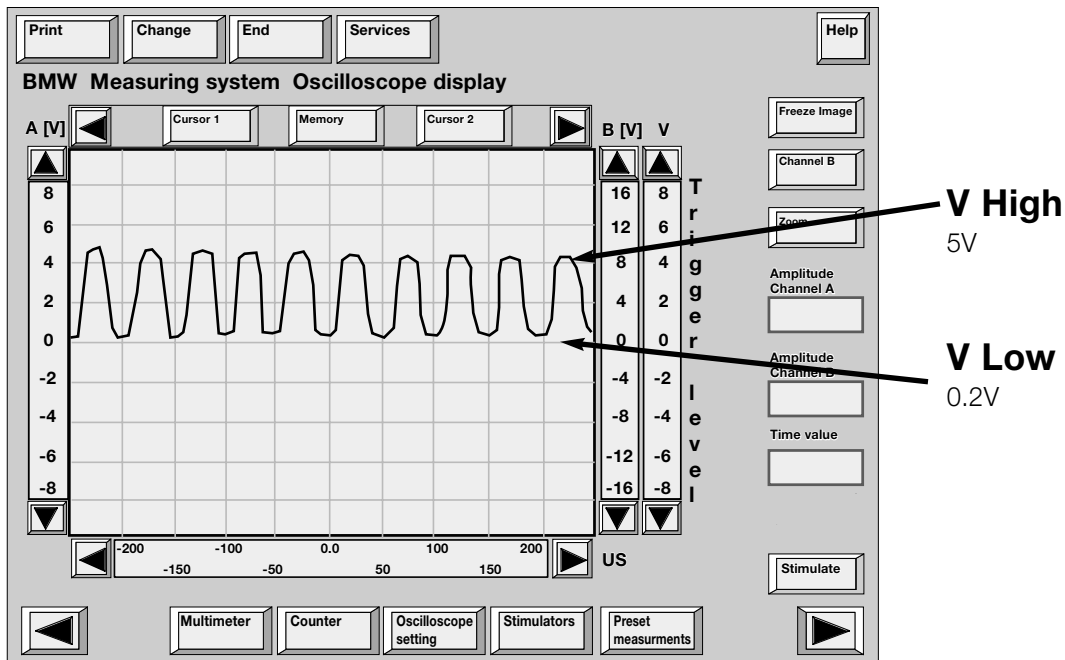

64400103

Example of correctly operating M-bus

Communication on the M-bus occurs continuously with an average Period duration of 50 μ s. When a command is issued by the IHK control unit the pattern will briefly change in period length and then return to the constant signal.

Failure of the Bus ribbon

The following faults can occur to the M-bus wiring:

- Short Circuit to B⁺
- Short Circuit to B⁻
- Bus line down (open)
- Defective plug connections (damaged, corroded, or improperly crimped)

The IHK control module checks the M-bus for continuous position feedback from the stepper motors. **If the M-bus is interrupted then the control unit will store a fault for every stepper motor on the bus.**

In order to determine if a stepper motor is at fault for the lack of communication, disconnect one stepper motor at a time while monitoring the M-bus signal line with a voltmeter or oscilloscope. The pattern or voltage should return to normal when the defective stepper is found. As a confirmation that communication is restored, change the setting on the IHK panel, if the remaining connected flap motors assume the selected position communication is OK.

Diagnosis of the M-bus is carried out by the DISplus/MoDiC via the IHK module. Available in the Diagnosis Program are:

- Fault/symptom driven test modules
- Diagnosis request (flap position)
- Component activation (flap activation)

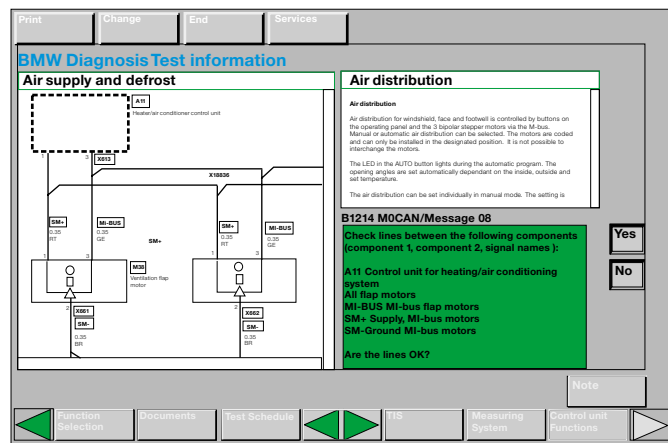

07400101

Review Questions

1. What should be the voltage preset at a CAN line if checked with a multi-meter? Is the voltage the same on both lines? _____

2. Where are the Terminal resistors located in the CAN bus network? What should the measured resistance of the CAN circuit be? How is it checked? _____

3. Explain the differences of CAN-High and CAN-Low? How can they be distinguished from one another? _____

4. Which control units on the CAN bus contribute to the voltage necessary for communication? Describe the method to determine if one control unit is affecting communication. _____

5. What is the minimum voltage required at the D-bus? _____

6. Why is checking a bus signal with an oscilloscope a practical option? _____

7. Describe some quick tests that can help to determine if a bus line is currently operating. _____